

15KPA-HR Series

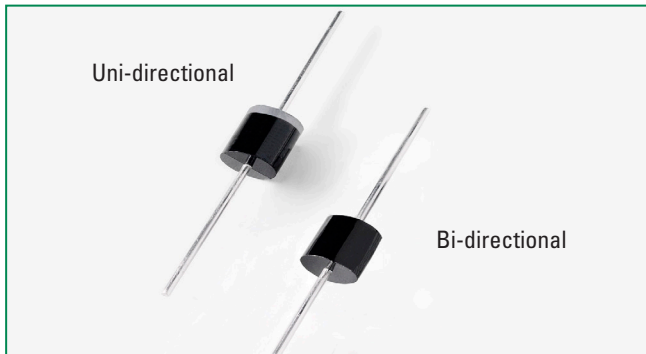

Agency Approvals

AGENCY	AGENCY FILE NUMBER
	E230531

Maximum Ratings and Thermal Characteristics (T_A = 25°C unless otherwise noted)

Parameter	Symbol	Value	Unit
Peak Pulse Power Dissipation by 10/1000µs Test Waveform (Fig.2) (Note 1)	P _{PPM}	15000	W
Steady State Power Dissipation on Infinite Heat Sink at T _L = 75°C (Fig. 6)	P _D	8.0	W
Peak Forward Surge Current, 8.3ms Single Half Sine Wave Unidirectional Only (Note 2)	I _{FSM}	400	A
Operating Junction and Storage Temperature Range	T _J , T _{STG}	-55 to 175	°C
Typical Thermal Resistance Junction to Lead	R _{θJL}	8.0	°C/W
Typical Thermal Resistance Junction to Ambient	R _{θJA}	40	°C/W

Notes:

1. Non-repetitive current pulse, per Fig. 4 and derated above T_J (initial) = 25°C per Fig. 3.
2. Measured on 8.3ms single half sine wave or equivalent square wave, duty cycle=4 per minute maximum.

Functional Diagram

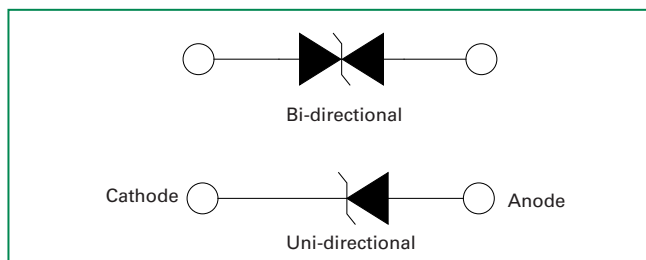

Descriptions

The 15KPA-HR High Reliability Series is designed specifically to protect sensitive electronic equipment from voltage transients induced by lightning and other transient voltage events.

Features

- 15000W peak pulse capability at 10/1000µs waveform, repetition rate (duty cycles):0.01%
- Glass passivated chip junction in P600 package
- Fast response time: typically less than 1.0ps from 0 Volts to BV min
- Excellent clamping capability
- Typical failure mode is short from over-specified voltage or current
- Whisker test is conducted based on JEDEC JESD201A per its table 4a and 4c
- IEC-61000-4-2 ESD 30kV(Air), 30kV (Contact)
- ESD protection of data lines in accordance with IEC 61000-4-2
- EFT protection of data lines in accordance with IEC 61000-4-4
- Low incremental surge resistance
- Typical I_R less than 2µA when V_{BR min}>36V
- High temperature soldering guaranteed: 260C/10 seconds / 0.375" (9.5mm) lead length, 5 lbs., (2.3kg) tension
- V_{BR} @ T_J = V_{BR} @ 25°C × (1 + α T × (T_J - 25)) (α T: Temperature Coefficient, typical value is 0.1%)
- Plastic package is flammability rated V-0 per Underwriters Laboratories
- Lead-free matte tin plated package
- Halogen free and RoHS compliant
- Pb-free E3 means 2nd level interconnect is Pb-free and the terminal finish material is tin(Sn) (IPC/ JEDEC J-STD-609A.01)

Applications

TVS devices are ideal for the protection of I/O interfaces, V_{CC} bus and other vulnerable circuits used in telecom, computer, industrial and consumer electronic applications.

Electrical Characteristics (T_A=25°C unless otherwise noted)

Part Number (Uni)	Part Number (Bi)	Reverse Stand off Voltage V _R (Volts)	Breakdown Voltage V _{BR} (Volts) @ I _T		Test Current I _T (mA)	Maximum Peak Pulse Current I _{PP} (A)	Maximum Reverse Leakage I _R @ V _R (μ A)	Maximum Clamping Voltage V _C @ I _{PP} (V)	Agency Approval 
			MIN	MAX					
15KPA17A-HR	15KPA17CA-HR	17	18.99	20.79	50	515.4	5000	29.3	X
15KPA18A-HR	15KPA18CA-HR	18	20.11	22.01	50	488.7	5000	30.9	X
15KPA20A-HR	15KPA20CA-HR	20	22.34	24.46	20	440.2	1500	34.3	X
15KPA22A-HR	15KPA22CA-HR	22	24.57	26.91	10	407.0	500	37.1	X
15KPA24A-HR	15KPA24CA-HR	24	26.81	29.35	5	371.0	150	40.7	X
15KPA26A-HR	15KPA26CA-HR	26	29.04	31.80	5	343.2	50	44.0	X
15KPA28A-HR	15KPA28CA-HR	28	31.28	34.24	5	317.9	25	47.5	X
15KPA30A-HR	15KPA30CA-HR	30	33.51	36.7	5	297.8	15	50.7	X
15KPA33A-HR	15KPA33CA-HR	33	36.9	40.4	5	276.1	2	54.7	X
15KPA36A-HR	15KPA36CA-HR	36	40.2	44.0	5	252.5	2	59.8	X
15KPA40A-HR	15KPA40CA-HR	40	44.7	48.9	5	229.5	2	65.8	X
15KPA43A-HR	15KPA43CA-HR	43	48.0	52.6	5	216.3	2	69.8	X
15KPA45A-HR	15KPA45CA-HR	45	50.3	55.0	5	207.4	2	72.8	X
15KPA48A-HR	15KPA48CA-HR	48	53.6	58.7	5	194.3	2	77.7	X
15KPA51A-HR	15KPA51CA-HR	51	57.0	62.4	5	182.1	2	82.9	X
15KPA54A-HR	15KPA54CA-HR	54	60.3	66.0	5	172.2	2	87.7	X
15KPA58A-HR	15KPA58CA-HR	58	64.8	70.9	5	161.0	2	93.8	X
15KPA60A-HR	15KPA60CA-HR	60	67.0	73.4	5	155.0	2	97.4	X
15KPA64A-HR	15KPA64CA-HR	64	71.5	78.3	5	144.9	2	104.2	X
15KPA70A-HR	15KPA70CA-HR	70	78.2	85.6	5	132.9	2	113.6	X
15KPA75A-HR	15KPA75CA-HR	75	83.8	91.7	5	123.8	2	122.0	X
15KPA78A-HR	15KPA78CA-HR	78	87.1	95.4	5	119.7	2	126.1	X
15KPA85A-HR	15KPA85CA-HR	85	94.9	104.0	5	109.7	2	137.6	X
15KPA90A-HR	15KPA90CA-HR	90	100.5	110.1	5	103.7	2	145.6	X
15KPA100A-HR	15KPA100CA-HR	100	111.7	122.3	5	93.6	2	161.3	X
15KPA110A-HR	15KPA110CA-HR	110	122.9	134.5	5	84.5	2	178.6	X
15KPA120A-HR	15KPA120CA-HR	120	134.0	146.8	5	78.5	2	192.3	X
15KPA130A-HR	15KPA130CA-HR	130	145.2	159.0	5	72.5	2	208.3	X
15KPA150A-HR	15KPA150CA-HR	150	167.6	183.5	5	62.4	2	241.9	X
15KPA160A-HR	15KPA160CA-HR	160	178.7	195.7	5	58.4	2	258.6	X
15KPA170A-HR	15KPA170CA-HR	170	189.9	207.9	5	55.4	2	272.7	X
15KPA180A-HR	15KPA180CA-HR	180	201.1	220.1	5	52.3	2	288.5	X
15KPA200A-HR	15KPA200CA-HR	200	223.4	244.6	5	47.3	2	319.1	X
15KPA220A-HR	15KPA220CA-HR	220	245.7	269.1	5	42.4	2	356.0	X
15KPA240A-HR	15KPA240CA-HR	240	268.1	293.5	5	39.3	2	384.6	X
15KPA260A-HR	15KPA260CA-HR	260	290.4	318.0	5	36.2	2	416.7	X
15KPA280A-HR	15KPA280CA-HR	280	312.8	342.4	5	33.2	2	454.5	X

Note:

1. For bidirectional type having V_R of 30 volts and less, the I_n limit is double.
2. Each lot of parts will pass group B test requirement.

Screen Process

100% Vision Inspection	MIL-STD-750 method 2074
100% High Temperature Storage Life (168hrs,175°C)	MIL-STD-750 method 1031
100% Temperature Cycle Test (-55 to150°C, 20 cycles, dwell time 15 min)	MIL-STD-750 method 1051
100% Surge Test (2x)	MIL-STD-750 method 4066
100% HTRB 150°C Bias=VR(80% breakdown voltage, 96hrs, and each direction at 96 hrs for Bi-directional products)	MIL-STD-750 method 1038
Final Electrical Test(100% 3 sigma limit, 100% dynamic test and PAT limit)	MIL-STD-750 method 4016.4021.4011

Note: Up-screen program can be specified by customer's request via contacting Littelfuse service

Group B Test Requirement

Screen	Method	Condition	Requirement
Surge test	10/1000 μ s Peak Pluse Waveform	Maximum clamping Voltage (V_c) @ Peak Plus Current (I_{pp})	Sample Size 45 perform 10x Accept 0 failures
Burn - In (HTRB)	MIL-STD-750, Method 1038.5	Applied voltage 100% V_R @150°C	Sample size 45 340 hours (680 hours for bi-direction products, each direction 340 hours) Accept 0 failures
Electrical test	--	I_R @ V_R , $V_{(BR)}$ @ I_T	Sample size 45 Accept 0 failures

I-V Curve Characteristics

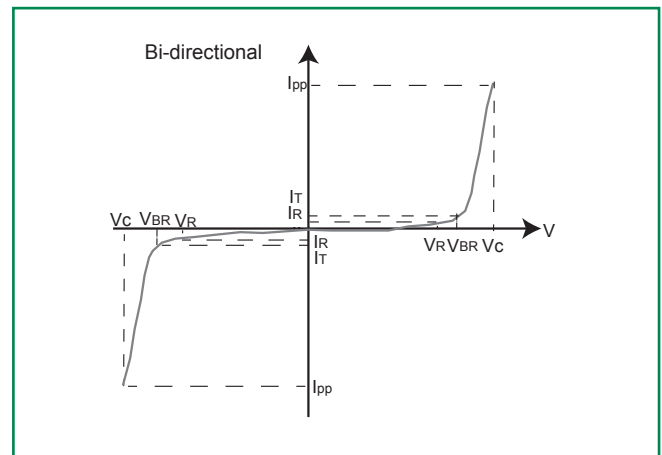
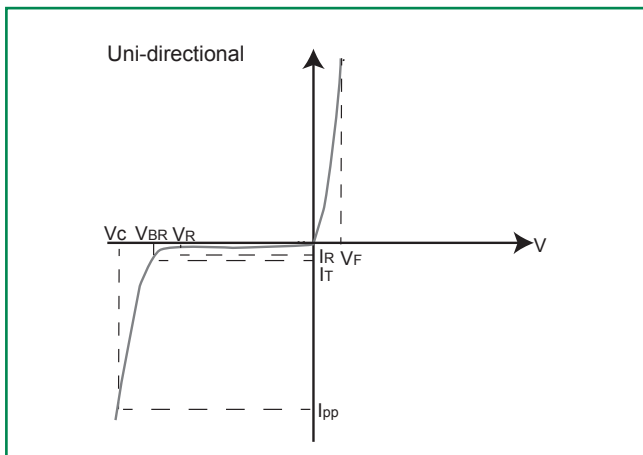

- P_{PPM} Peak Pulse Power Dissipation** – Max power dissipation
- V_R Stand-off Voltage** – Maximum voltage that can be applied to the TVS without operation
- V_{BR} Breakdown Voltage** – Maximum voltage that flows though the TVS at a specified test current (I_r)
- V_c Clamping Voltage** – Peak voltage measured across the TVS at a specified I_{ppm} (peak impulse current)
- I_r Reverse Leakage Current** – Current measured at V_R
- V_f Forward Voltage Drop for Uni-directional**

Ratings and Characteristic Curves ($T_A=25^{\circ}\text{C}$ unless otherwise noted)

Figure 1 - TVS Transients Clamping Waveform

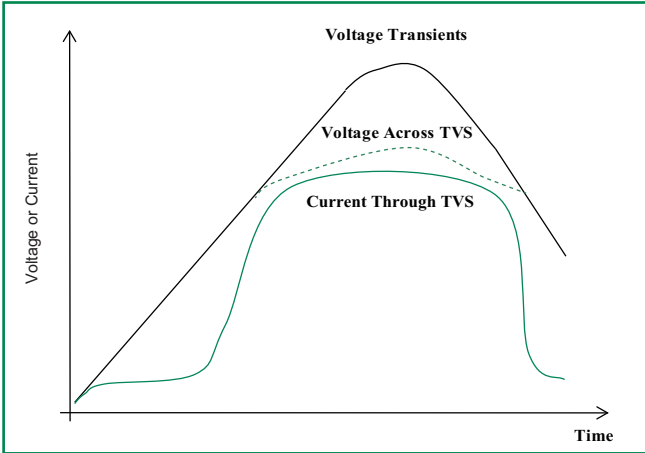

Figure 2 - Peak Pulse Power Rating Curve

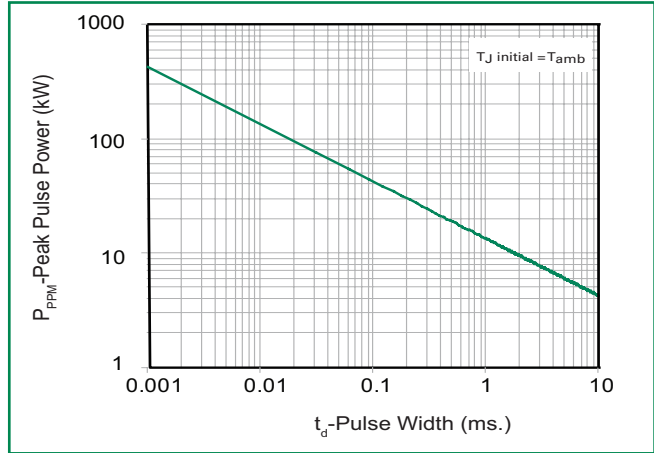

Figure 3 - Peak Pulse Power Derating Curve

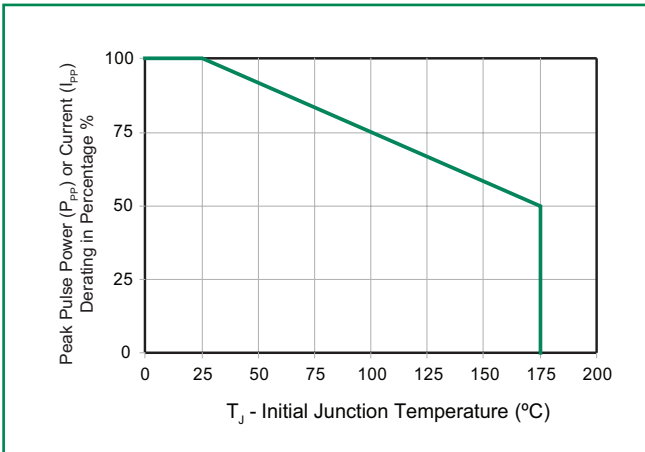

Figure 4 - Test Pulse Waveform

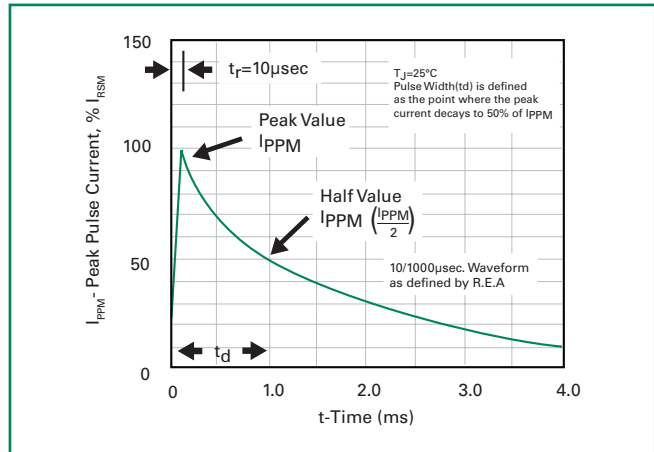

Figure 5 - Typical Junction Capacitance

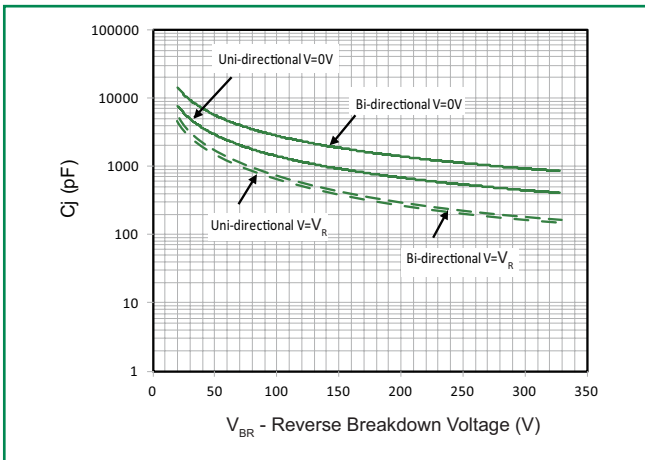

Figure 6 - Typical Transient Thermal Impedance

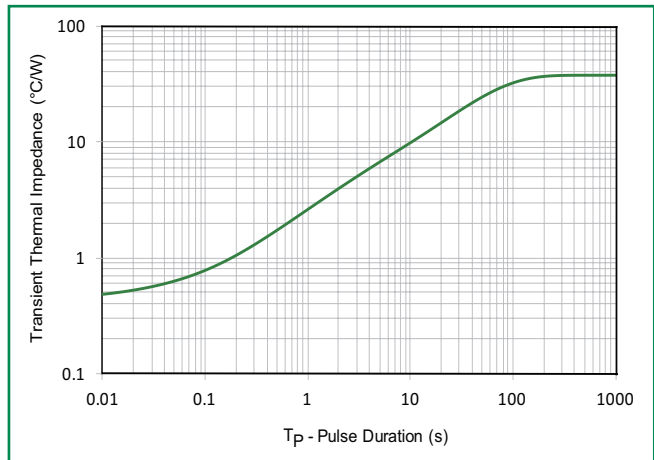

Figure 7 - Maximum Non-Repetitive Peak Forward Surge Current Uni-Directional Only

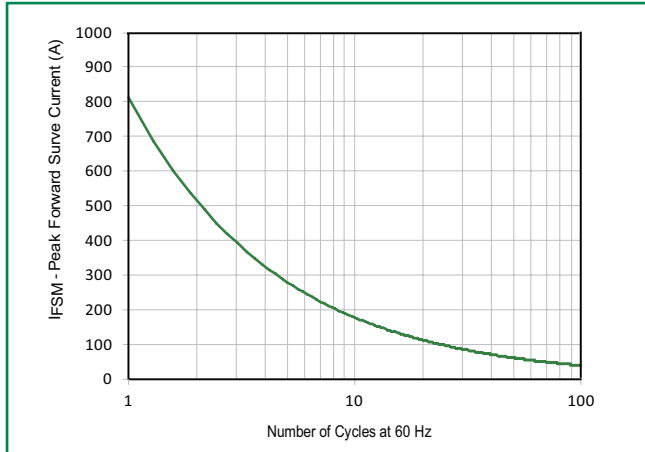
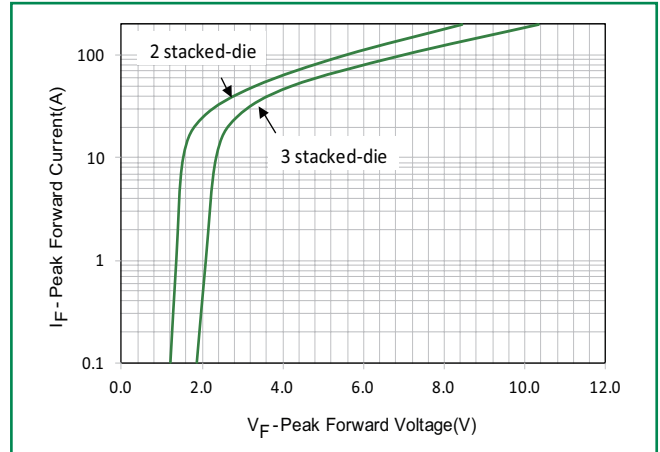

Figure 8 - Peak Forward Voltage Drop vs Peak Forward Current (Typical Values)



Physical Specifications

Weight	0.07oz., 2.5g
Case	P600 molded plastic body over passivated junction.
Polarity	Color band denotes the cathode except Bipolar.
Terminal	Matte Tin axial leads, solderable per JESD22-B102.

Environmental Specifications

High Temp. Storage	JESD22-A103
HTRB	JESD22-A108
Temperature Cycling	JESD22-A104
H3TRB	JESD22-A101
RSH	JESD22-B106

Dimensions

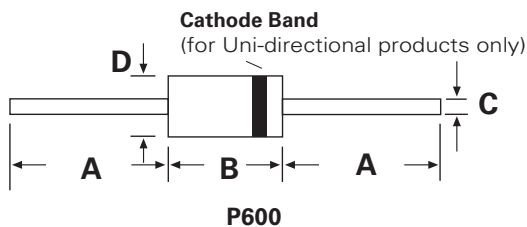

Dimensions	Inches		Millimeters	
	Min	Max	Min	Max
A	1.000	-	25.40	-
B	0.340	0.360	8.60	9.10
C	0.048	0.052	1.22	1.32
D	0.340	0.360	8.60	9.10

Packing Options

Part Number	Component Package	Quantity	Packaging Option	Packaging Specification
15KPAxxxXX-HR	P600	800	Tape & Reel	EIA STD RS-296

Part Numbering System

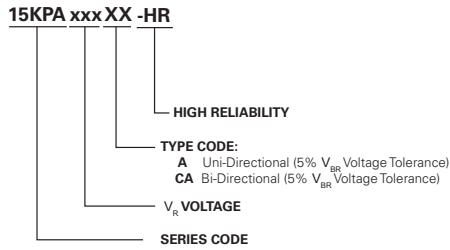

Part Marking System

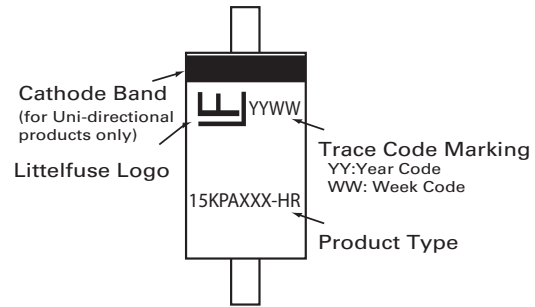

Tape and Reel Specification

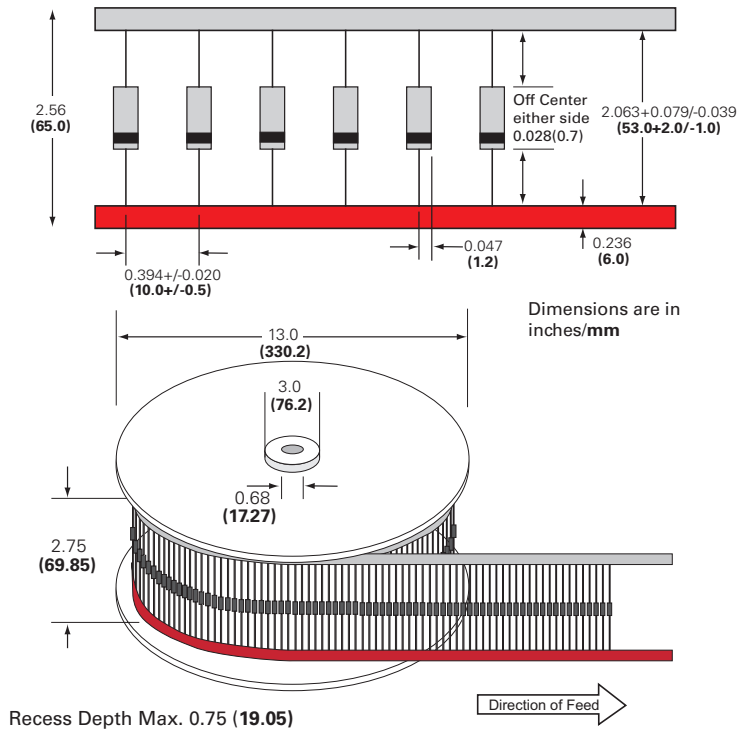

RTCA/DO-160G Wave 4 and Wave 5

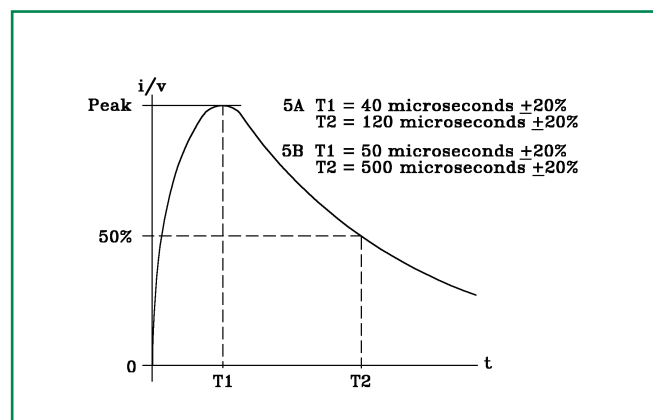
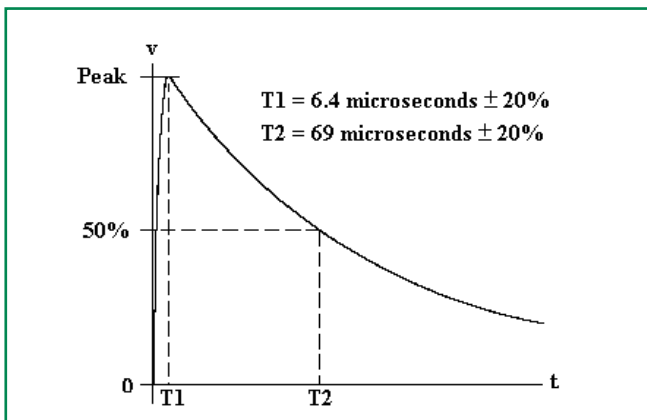

Pin Injection Protection Per RTCA/DO-160G

Part Number (Uni)	Part Number (Bi)	25C					70C					120C				
		Wave 4 (6.4/69us)			Wave 5a (40/120us)		Wave 4 (6.4/69us)			Wave 5a (40/120us)		Wave 4 (6.4/69us)			Wave 5a (40/120us)	
		L3	L4	L5	L3	L4	L3	L4	L5	L3	L4	L3	L4	L5	L3	L4
		60A	150A	320A	300A	750A	60A	150A	320A	300A	750A	60A	150A	320A	300A	750A
15KPA17A-HR	15KPA17CA-HR	pass	pass	pass	pass	pass	pass	pass	pass	pass	pass	pass	pass	pass	pass	pass
15KPA18A-HR	15KPA18CA-HR	pass	pass	pass	pass	pass	pass	pass	pass	pass	pass	pass	pass	pass	pass	pass
15KPA20A-HR	15KPA20CA-HR	pass	pass	pass	pass	pass	pass	pass	pass	pass	pass	pass	pass	pass	pass	pass
15KPA22A-HR	15KPA22CA-HR	pass	pass	pass	pass	pass	pass	pass	pass	pass	pass	pass	pass	pass	pass	pass
15KPA24A-HR	15KPA24CA-HR	pass	pass	pass	pass	pass	pass	pass	pass	pass	pass	pass	pass	pass	pass	-
15KPA26A-HR	15KPA26CA-HR	pass	pass	pass	pass	pass	pass	pass	pass	pass	pass	pass	pass	pass	pass	-
15KPA28A-HR	15KPA28CA-HR	pass	pass	pass	pass	pass	pass	pass	pass	pass	pass	pass	pass	pass	pass	-
15KPA30A-HR	15KPA30CA-HR	pass	pass	pass	pass	pass	pass	pass	pass	pass	pass	pass	pass	pass	pass	-
15KPA33A-HR	15KPA33CA-HR	pass	pass	pass	pass	pass	pass	pass	pass	pass	pass	pass	pass	pass	pass	-
15KPA36A-HR	15KPA36CA-HR	pass	pass	pass	pass	pass	pass	pass	pass	pass	pass	pass	pass	pass	pass	-
15KPA40A-HR	15KPA40CA-HR	pass	pass	pass	pass	pass	pass	pass	pass	pass	pass	pass	pass	pass	pass	-
15KPA43A-HR	15KPA43CA-HR	pass	pass	pass	pass	pass	pass	pass	pass	pass	pass	pass	pass	pass	pass	-
15KPA45A-HR	15KPA45CA-HR	pass	pass	pass	pass	pass	pass	pass	pass	pass	pass	pass	pass	pass	pass	-
15KPA48A-HR	15KPA48CA-HR	pass	pass	pass	pass	-	pass	pass	pass	pass	-	pass	pass	pass	pass	-
15KPA51A-HR	15KPA51CA-HR	pass	pass	pass	pass	-	pass	pass	pass	pass	-	pass	pass	pass	pass	-
15KPA54A-HR	15KPA54CA-HR	pass	pass	pass	pass	-	pass	pass	pass	pass	-	pass	pass	pass	pass	-
15KPA58A-HR	15KPA58CA-HR	pass	pass	pass	pass	-	pass	pass	pass	pass	-	pass	pass	pass	-	-
15KPA60A-HR	15KPA60CA-HR	pass	pass	pass	pass	-	pass	pass	pass	pass	-	-	pass	pass	pass	-
15KPA64A-HR	15KPA64CA-HR	pass	pass	pass	pass	-	pass	pass	pass	-	-	pass	pass	pass	-	-
15KPA70A-HR	15KPA70CA-HR	pass	pass	pass	pass	-	pass	pass	pass	-	-	pass	pass	pass	-	-
15KPA75A-HR	15KPA75CA-HR	pass	pass	pass	pass	-	pass	pass	pass	-	-	pass	pass	pass	-	-
15KPA78A-HR	15KPA78CA-HR	pass	pass	pass	pass	-	pass	pass	pass	-	-	pass	pass	pass	-	-
15KPA85A-HR	15KPA85CA-HR	pass	pass	pass	pass	-	pass	pass	pass	-	-	pass	pass	pass	-	-
15KPA90A-HR	15KPA90CA-HR	pass	pass	pass	pass	-	pass	pass	pass	-	-	pass	pass	pass	-	-
15KPA100A-HR	15KPA100CA-HR	pass	pass	pass	-	-	pass	pass	pass	-	-	pass	pass	pass	-	-
15KPA110A-HR	15KPA110CA-HR	pass	pass	pass	-	-	pass	pass	pass	-	-	pass	pass	pass	-	-
15KPA120A-HR	15KPA120CA-HR	pass	pass	pass	-	-	pass	pass	pass	-	-	pass	pass	pass	-	-
15KPA130A-HR	15KPA130CA-HR	pass	pass	pass	-	-	pass	pass	pass	-	-	pass	pass	-	-	-
15KPA150A-HR	15KPA150CA-HR	pass	pass	pass	-	-	pass	pass	pass	-	-	pass	pass	-	-	-
15KPA160A-HR	15KPA160CA-HR	pass	pass	pass	-	-	pass	pass	-	-	-	pass	pass	-	-	-
15KPA170A-HR	15KPA170CA-HR	pass	pass	pass	-	-	pass	pass	-	-	-	pass	pass	-	-	-
15KPA180A-HR	15KPA180CA-HR	pass	pass	pass	-	-	pass	pass	-	-	-	pass	-	-	-	-
15KPA200A-HR	15KPA200CA-HR	pass	pass	pass	-	-	pass	pass	-	-	-	pass	-	-	-	-
15KPA220A-HR	15KPA220CA-HR	pass	pass	pass	-	-	pass	-	-	-	-	pass	-	-	-	-
15KPA240A-HR	15KPA240CA-HR	pass	pass	pass	-	-	pass	-	-	-	-	pass	-	-	-	-
15KPA260A-HR	15KPA260CA-HR	pass	pass	-	-	-	pass	-	-	-	-	pass	-	-	-	-
15KPA280A-HR	15KPA280CA-HR	pass	pass	-	-	-	pass	-	-	-	-	pass	-	-	-	-

Note:

1. L1 = Level1, L2 = Level 2, L3 = Level 3, L4 = Level 4, L5 = Level 5